



















S3000



Fill & Pan Section

-  1. Hot water basin
-  2. Flow balancing valve kit
-  3. Nozzles
-  4. Distribution basin covers(option)
-  5. Fill sheets with integrated drift eliminators
-  6. Air inlet louvers
-  7. Fan cylinder
-  8. Fan guard
-  9. Axial fan assembly (see detailed view)
-  10. Make-up valve assembly
-  11. Float ball
-  12. Access door (not visible)
-  13. Motor base & adjust rod
-  14. Pan strainer
-  15. Pan strainer hood
-  16. Heater
-  17. Low level cut out switch
-  18. Heater thermostat

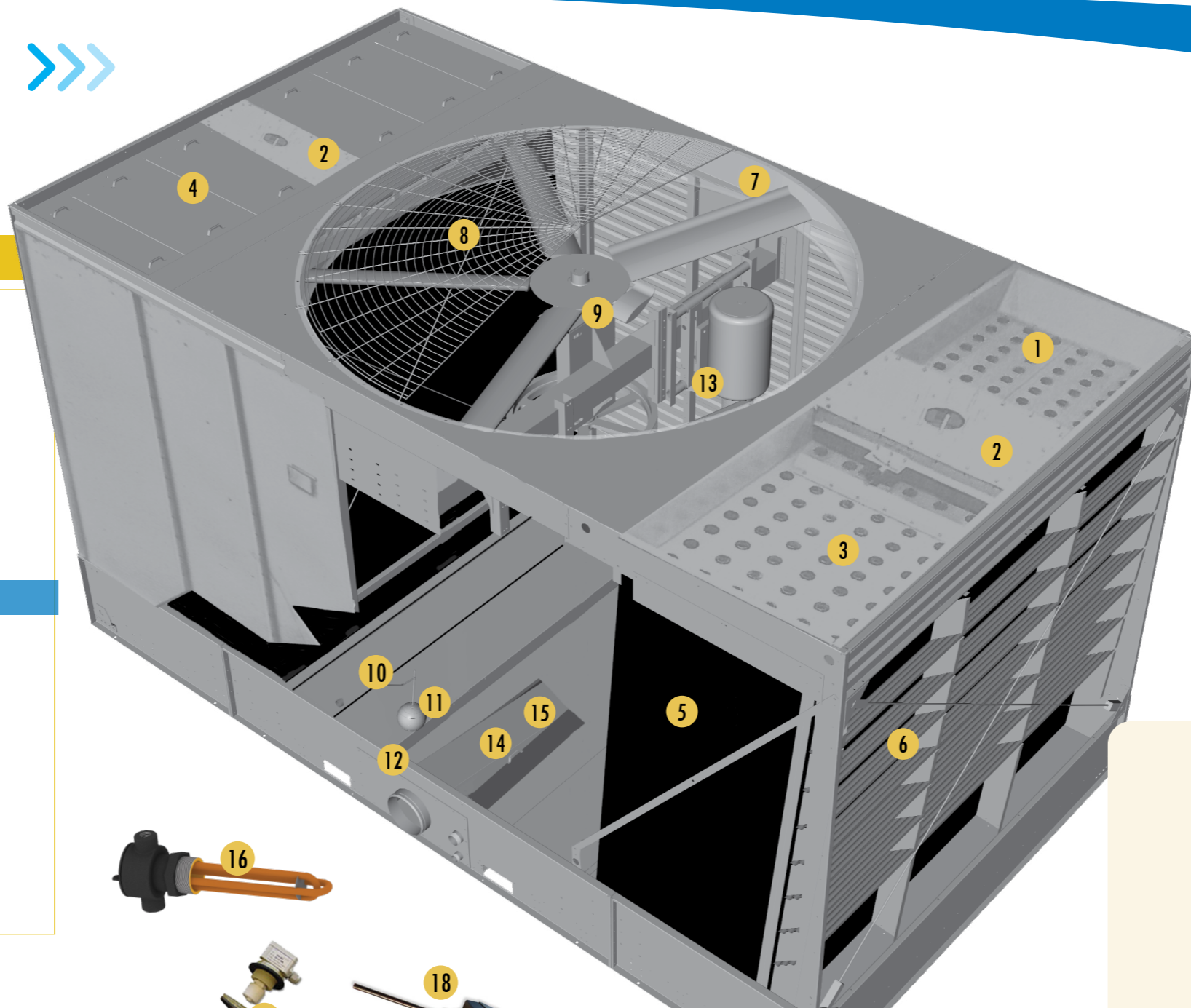











Client contact information

Name _____
 Company _____
 Telephone _____
 Email _____
 Unit model _____
 Serial number _____

Your BAC contact

Name _____
 Telephone _____
 Email _____

Axial fan assembly

-  A. Axial fan
-  B. Fan bushing
-  C. Fan shaft
-  D. Bearing with flinger collar
-  E. Fan locking collar
-  F. Bearing support
-  G. Impervix Fan motor
-  H. Drive set
-  Motor sheave & bushing
-  Aluminium fan sheave & bushing
-  Belt set

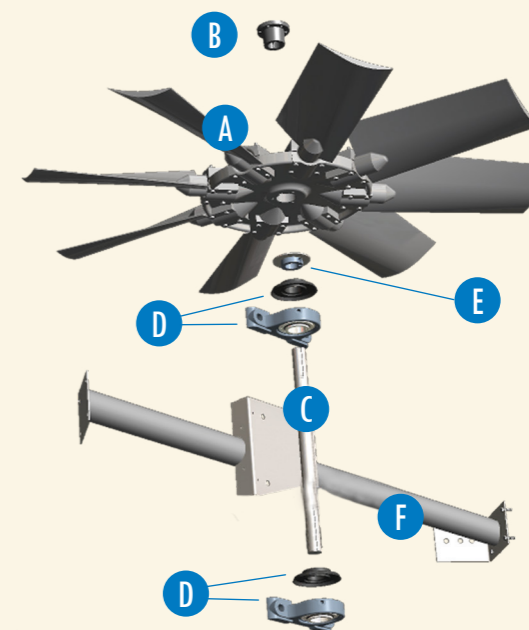

Quantities may vary according to the unit type.

Spare parts for cooling tower

